

* Possible uniquement en TA
Possible only without thermal break

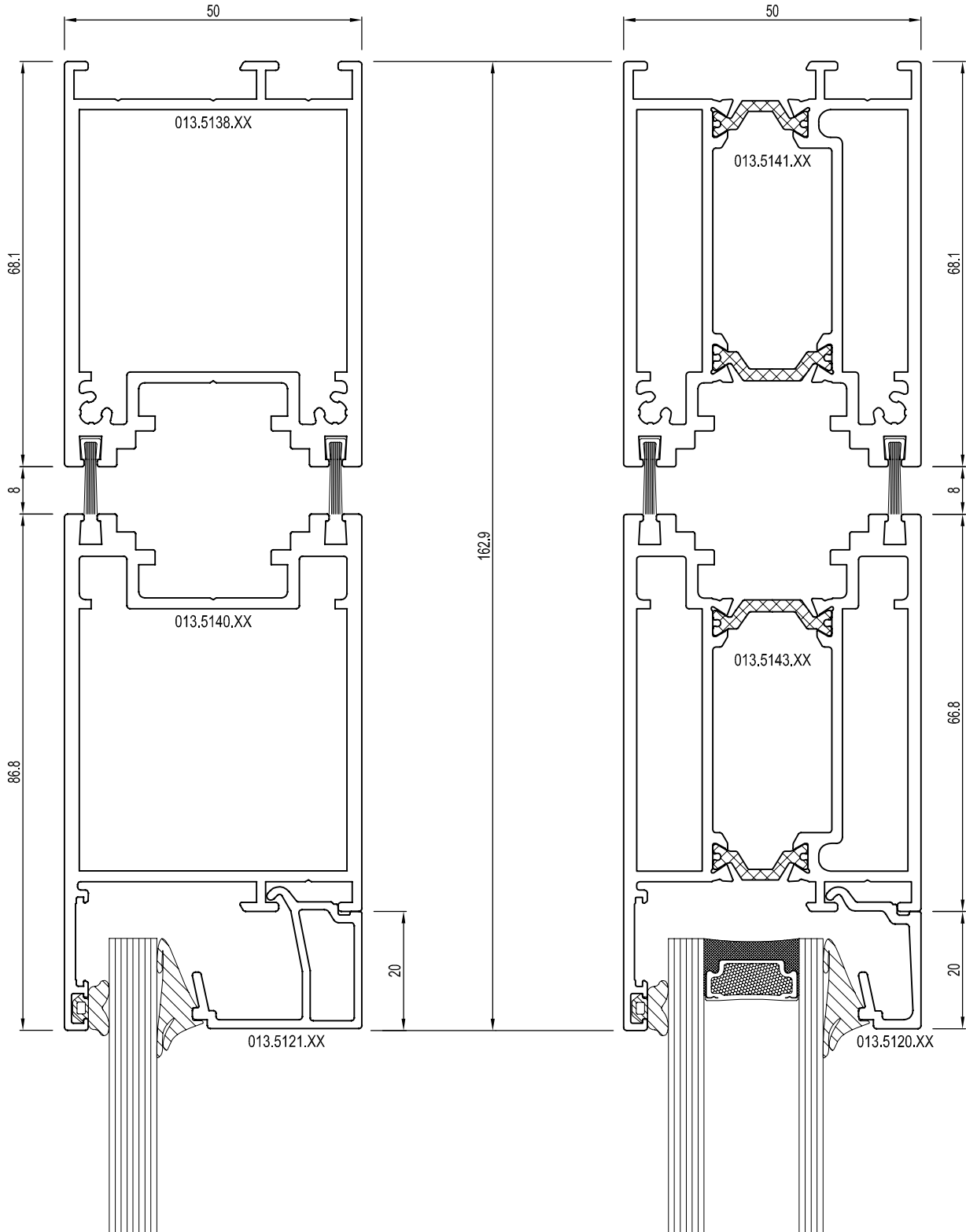

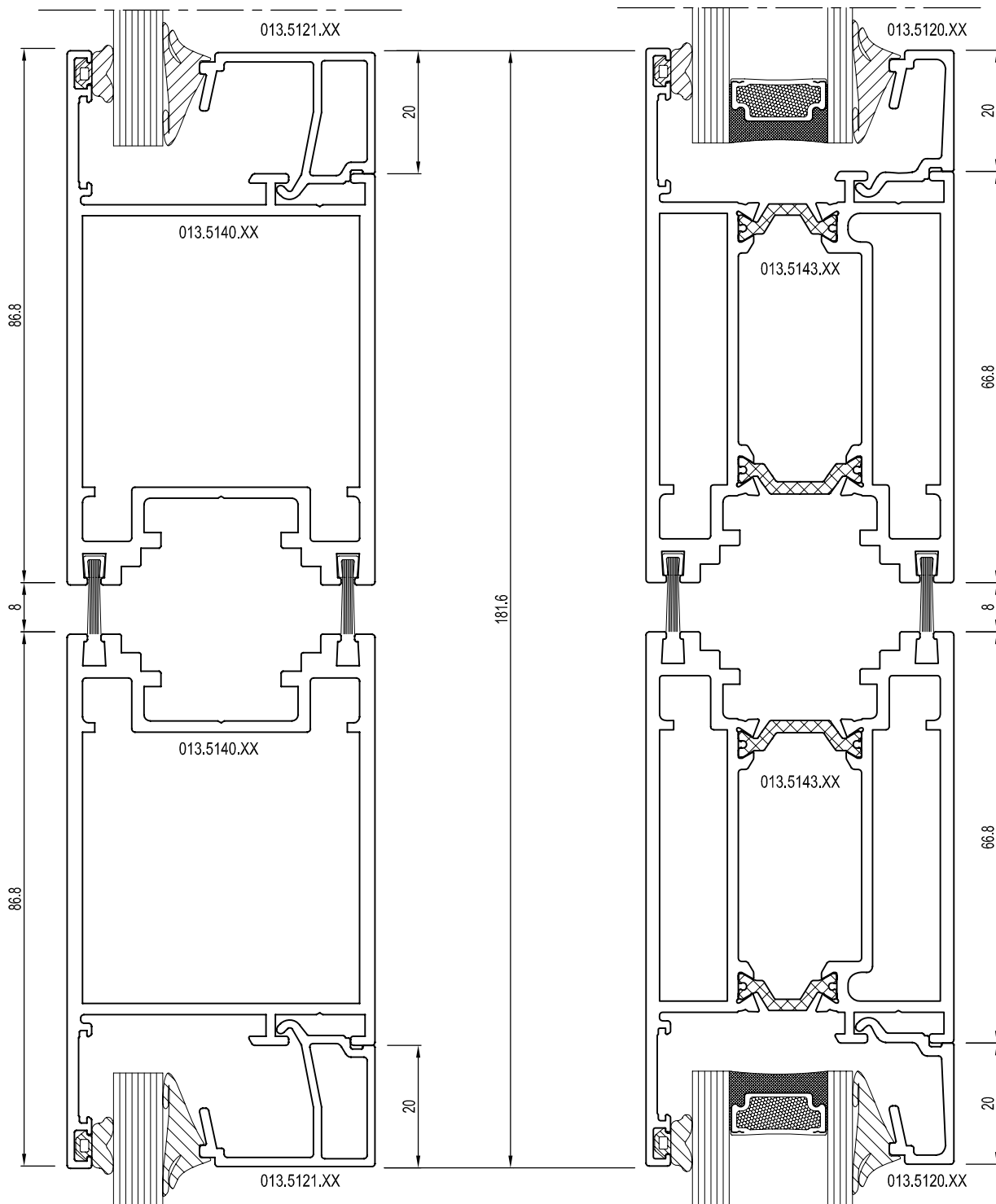

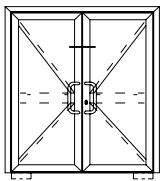
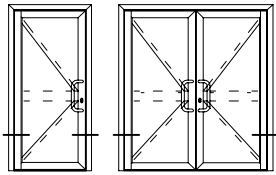

Informations Anti Pince Doigts : voir page 84D.b.001
Finger protection informations : see board 84D.b.001

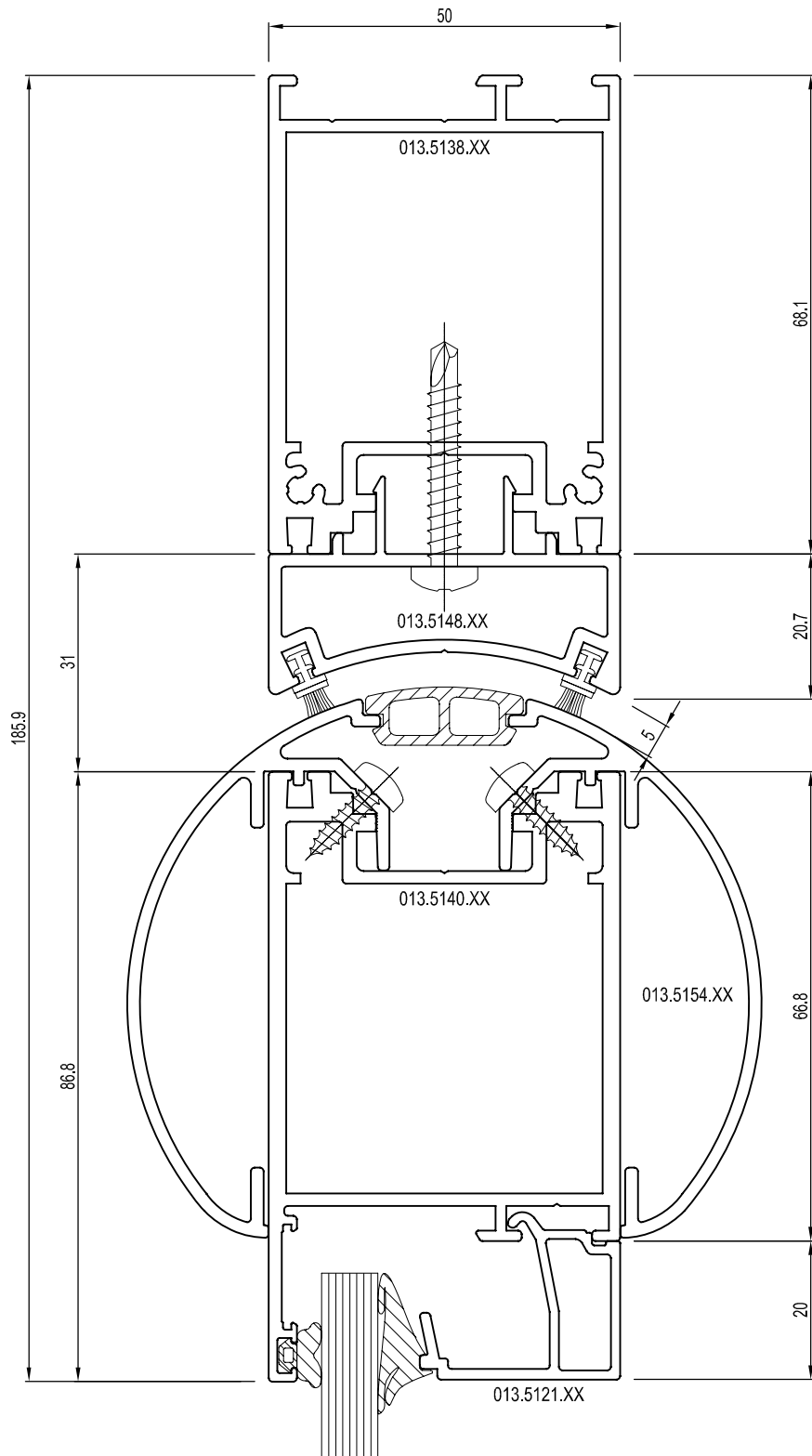

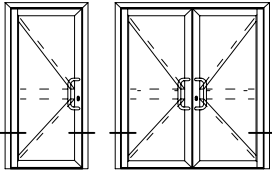

Informations Anti Pince Doigts : voir page 84D.b.001
Finger protection informations : see board 84D.b.001

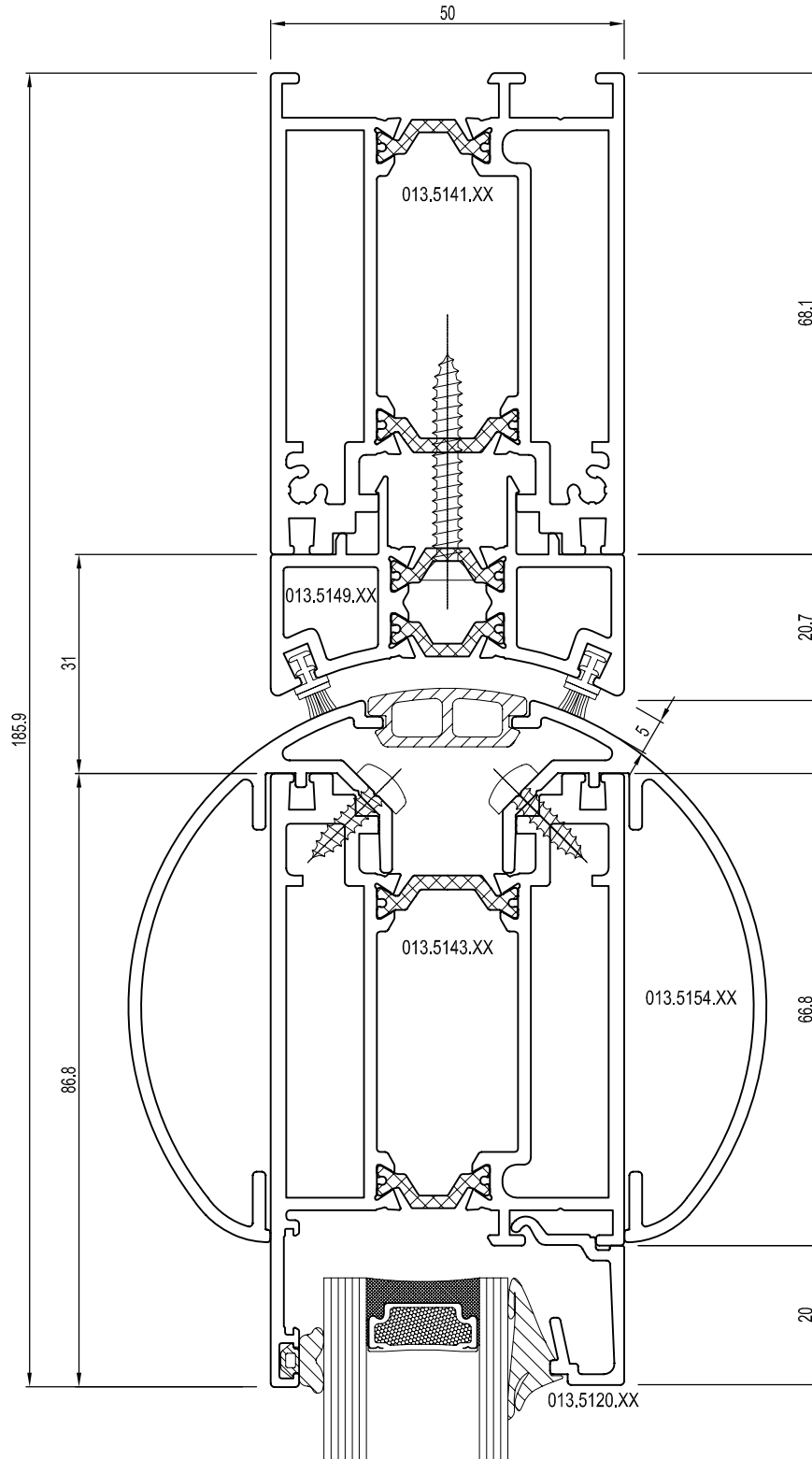

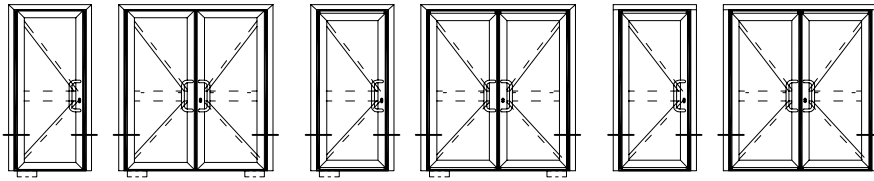

Informations Anti Pince Doigts :
voir page 84D.b.001
Finger protection informations :
see board 84D.b.001

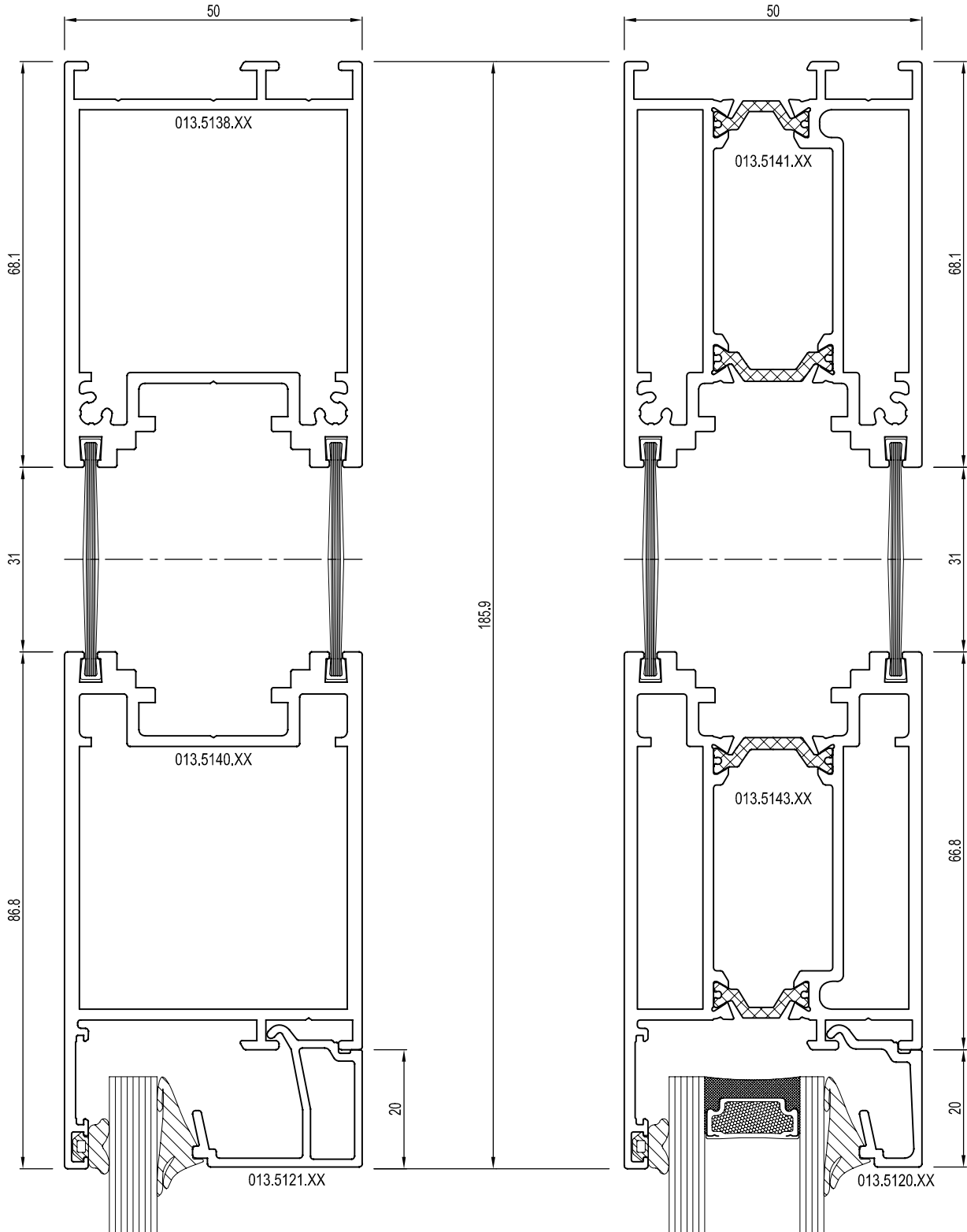

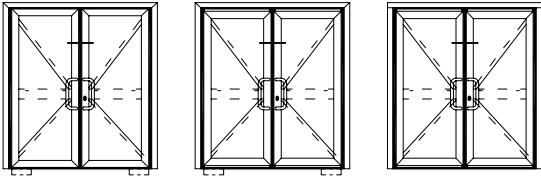

Informations Anti Pince Doigts : voir page 84D.b.001
Finger protection informations : see board 84D.b.001

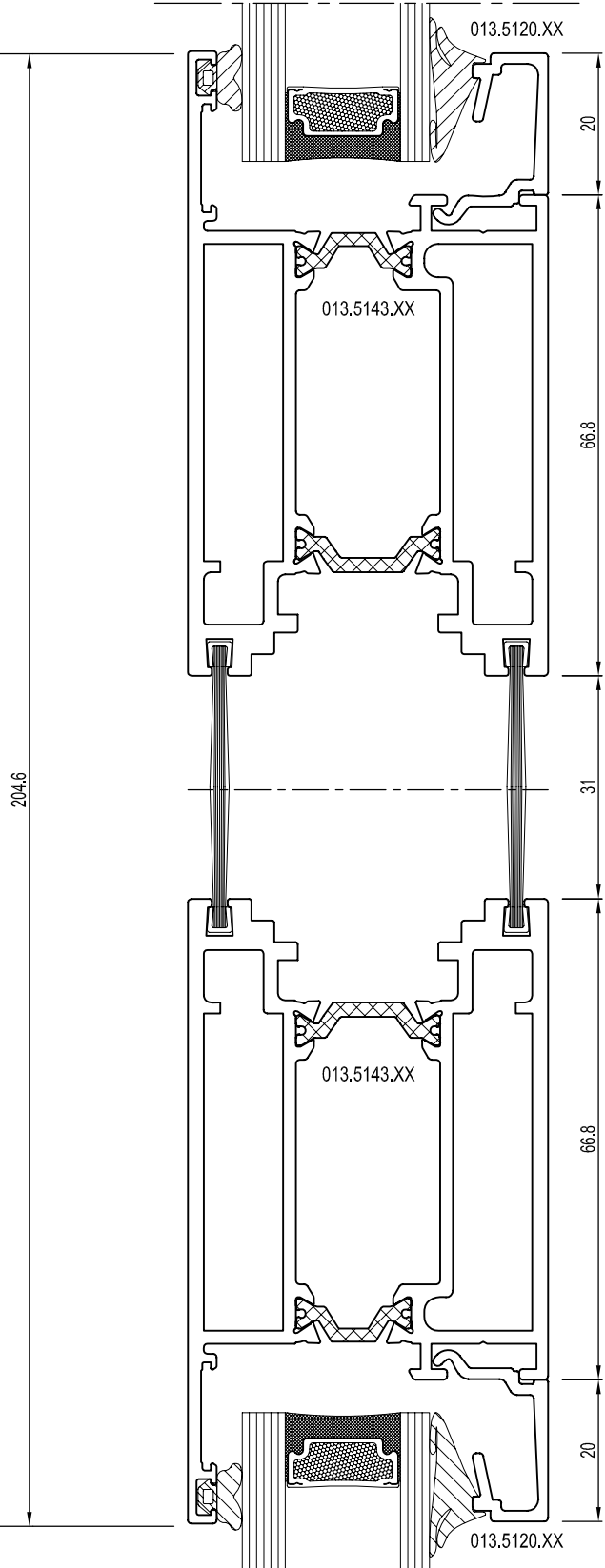
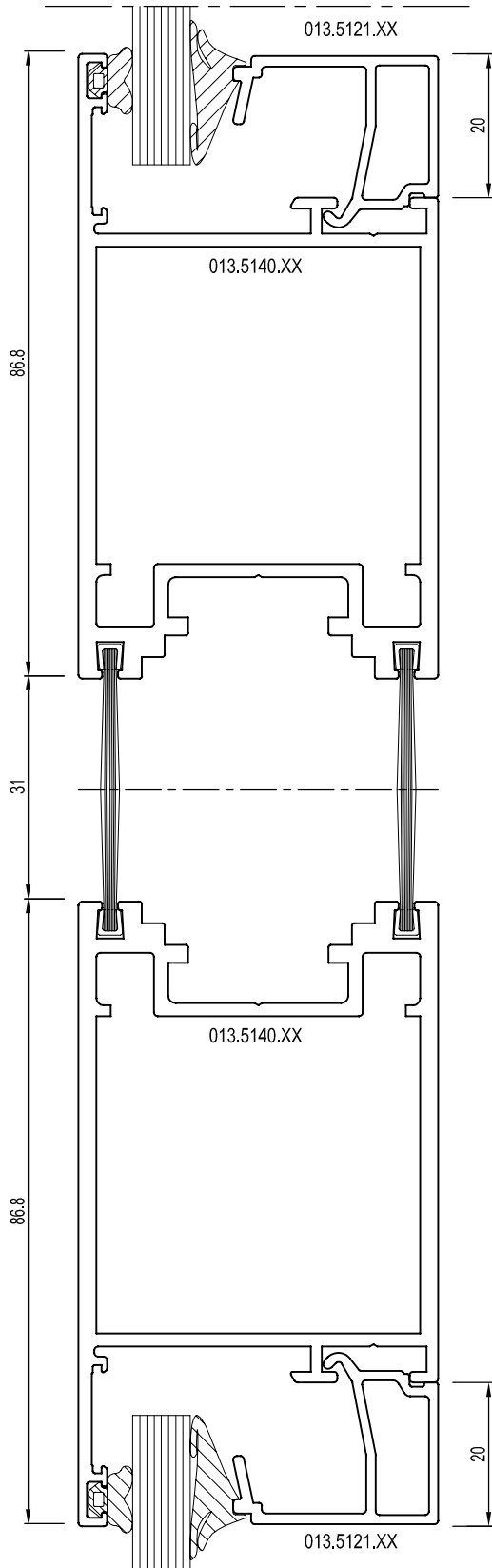

CD 50-SD

PORTE-VA-ET-VIENT OUVR. + PIVOT DE FREIN AERIEN
SWING DOOR VENT + OVERHEAD CLOSER

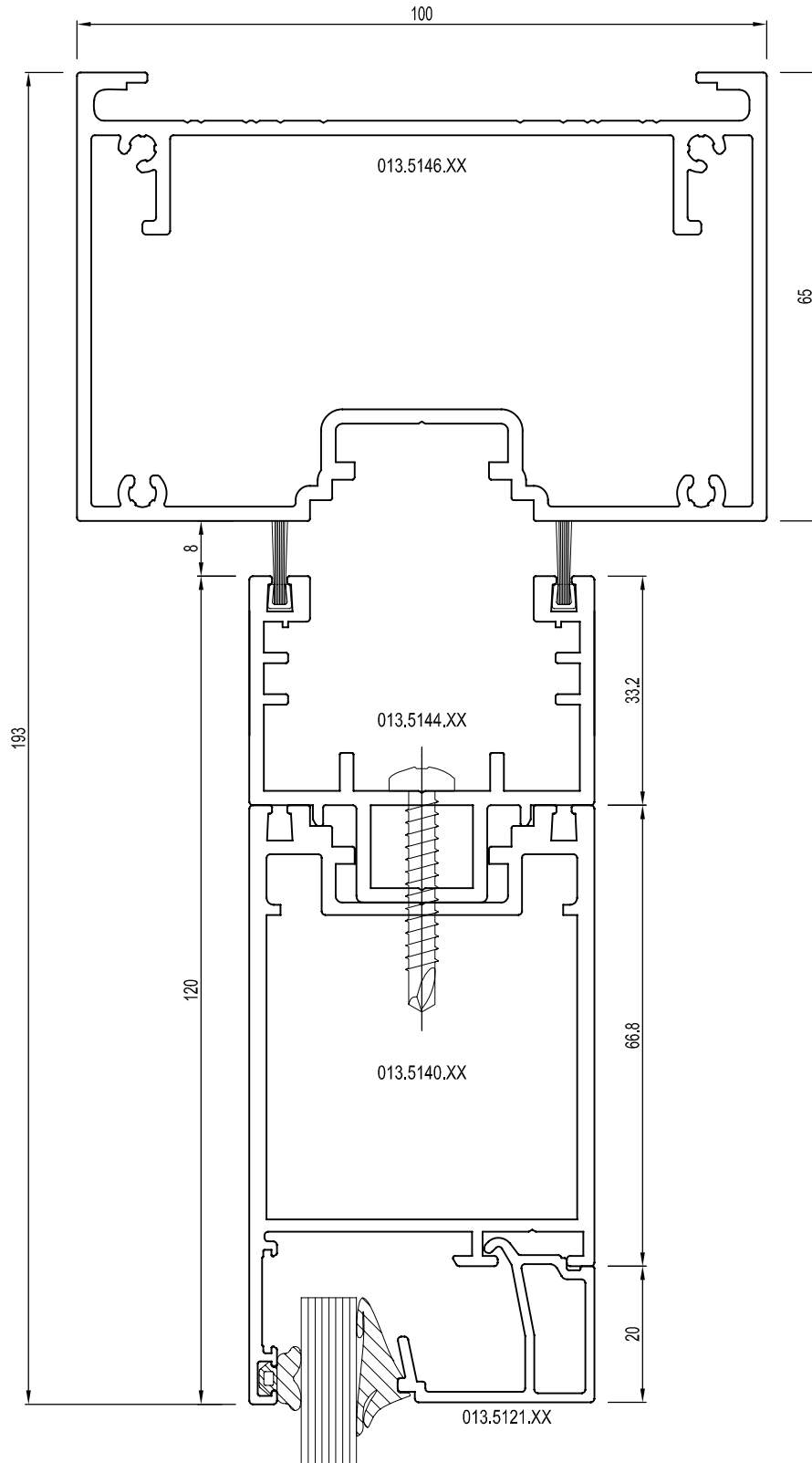
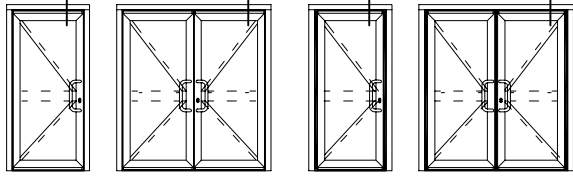

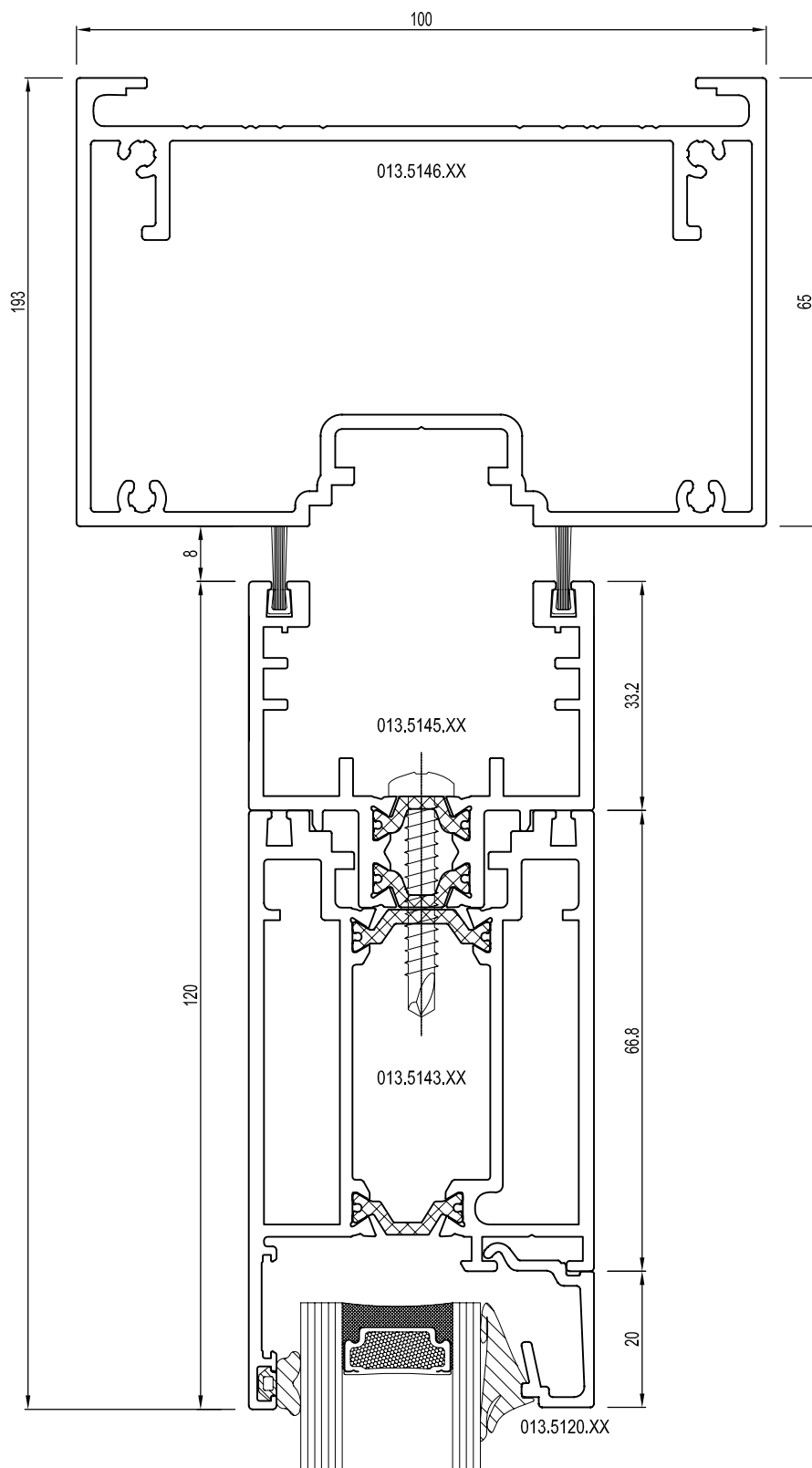
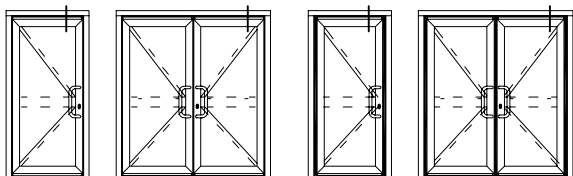

CD 50-SD

PORTE-VA-ET-VIENT DORMANT OUVRANT
SWING DOOR OUTER FRAME VENT

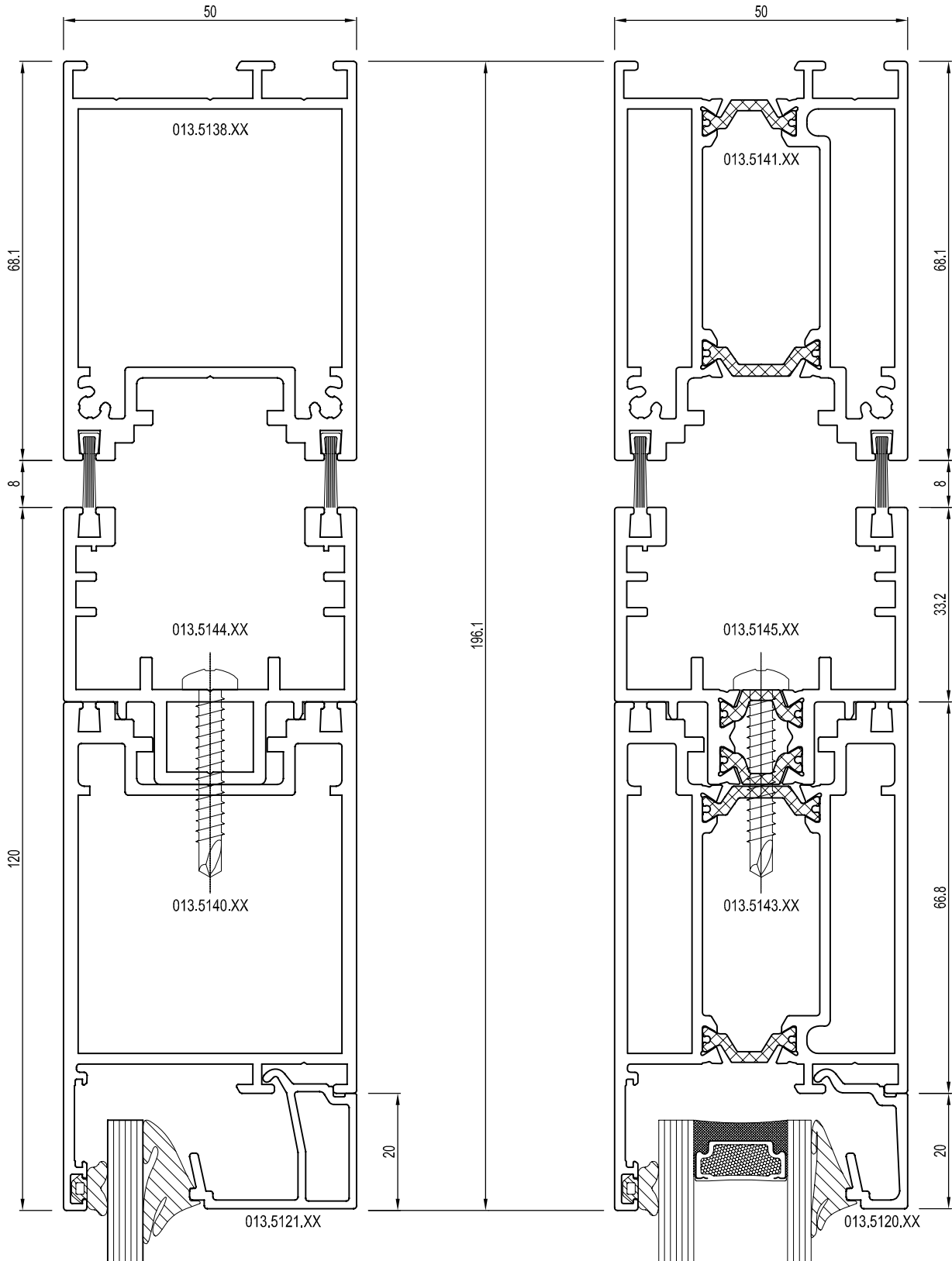
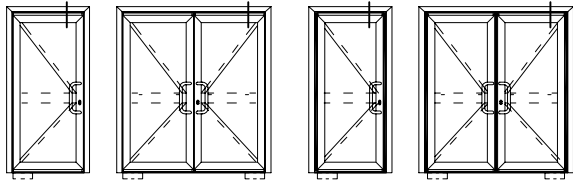

CD 50-SD

PORTE VA-ET-VIENT
SWING DOOR

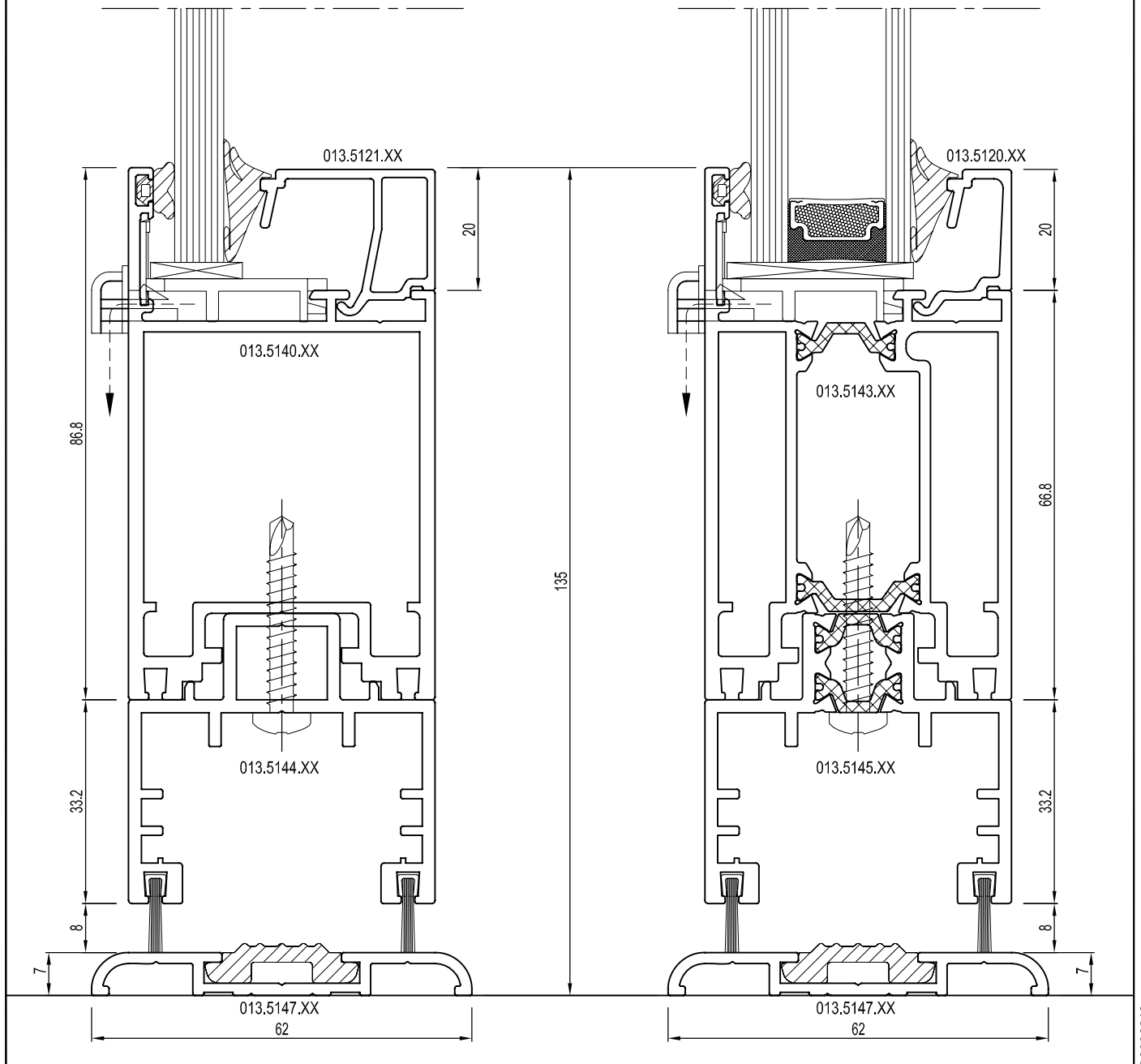
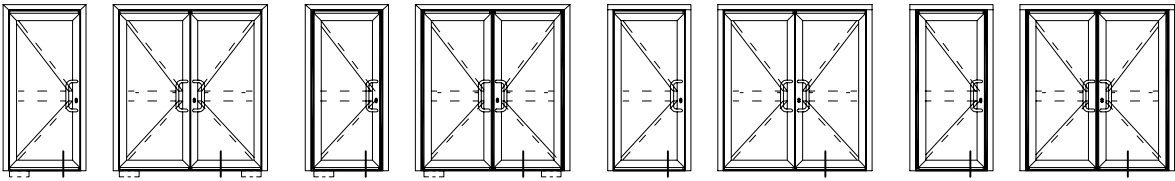
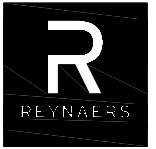

CD 50-SD

PORTE VA-ET-VIENT
SWING DOOR

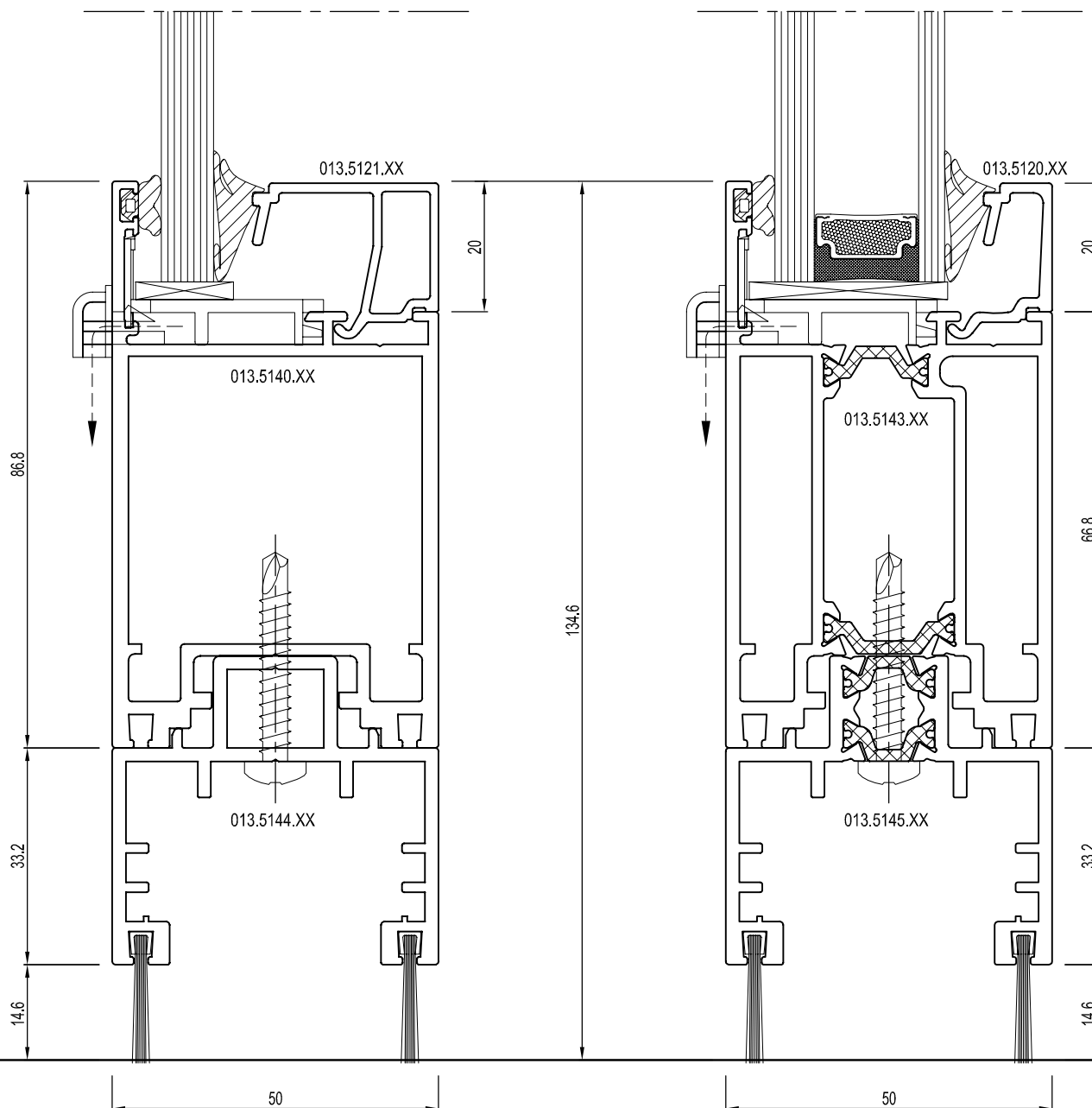
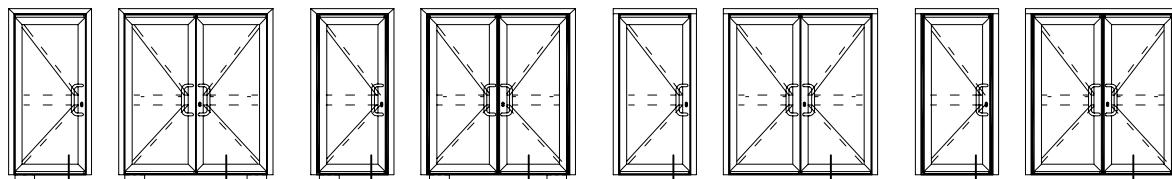
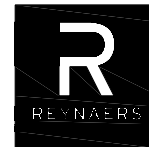

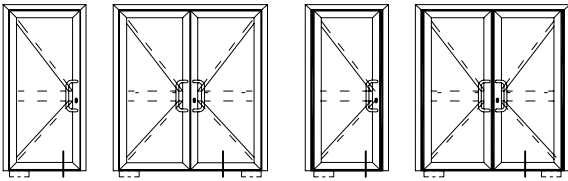

Uniquement en TA
Only without thermal break

